



Changes for the Better

PASSENGER ELEVATORS

for a greener tomorrow



Quality
inMotion

NEXIEZ -MR



2nd Edition



Utilizing its technological prowess and extensive experience, Mitsubishi Electric has remained a leader in the vertical transportation market since entering the business in 1931. The Company's creative, innovative spirit, represented by production of the world's first spiral escalator and elevator group-control systems that use artificial-intelligence technologies, continues to receive high evaluations industry-wide. Our products and systems are renowned for their high levels of quality, reliability and safety; and it is this sense of security and trust fostered with building owners and end-users alike that has led to the global expansion of our elevator/escalator business and the after-sales network to service it.

We understand responsibilities as a good corporate citizen, and continue to implement measures for protecting the environment and ensuring a sustainable society for future generations. A number of original technologies are being introduced to ensure more efficient products, systems and manufacturing operations, thereby enhancing productivity, reducing energy consumption and providing smoother, faster and more comfortable vertical transportation systems.

三菱電機
SOLWE

Principle

Based on our policy, "Quality in Motion", we provide elevators and escalators that will satisfy our customers with high levels of comfort, efficiency, ecology and safety.

Quality in Motion

Comfort

Efficiency

Ecology

Safety

Mitsubishi Electric elevators, escalators and building management systems are always evolving, helping achieve our goal of being the No.1 brand in quality. In order to satisfy customers in all aspects of comfort, efficiency and safety while realizing a sustainable society, quality must be of the highest level in all products and business activities, while priority is place on consideration for the environment. As the times change, Mitsubishi Electric promises to utilize the collective strengths of its advanced and environmental technologies to offer its customers safe and reliable products while contributing to society.

We strive to be green in all of our business activities.

We take every action to reduce environmental burden during each process of our elevators' and escalators' lifecycle.



Contents

● Ecology

Using Energy Wisely

7-8

- Regenerative Converter
- Traction Machine with PM Motor
- LED Lighting
- Energy-saving Features

● Efficiency

Smooth Mobility through Efficient Group Control

9-11

- Group Control Systems
- Cooperative Optimization Assignment
- Energy-Saving Operation—Allocation Control
- Dynamic Rule-set Optimizer
- Destination Oriented Allocation System

● Safety and Comfort

Providing a Safe, Comfortable Ride

12-14

- Emergency Operation
- Door Safety Devices
- User-oriented Design

Standard Design

15

Features

16-18

Basic Specifications

19-24

Important Information on Elevator Planning

25

Application

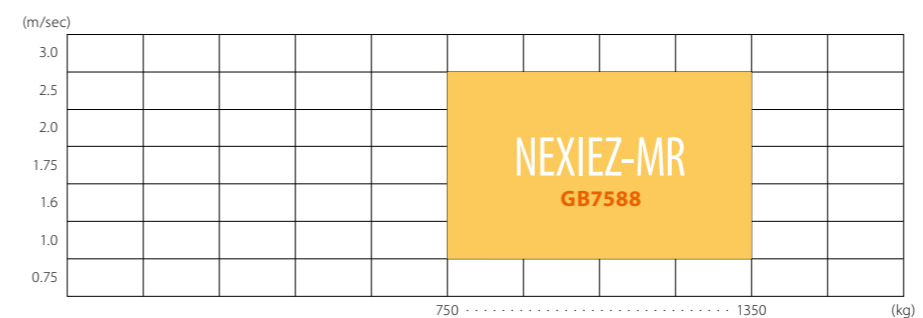
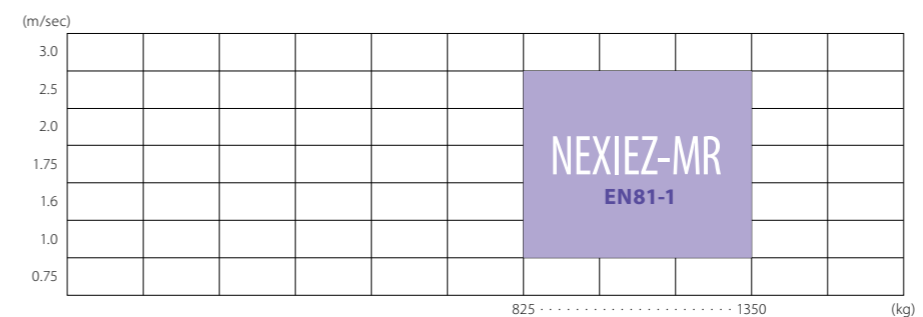
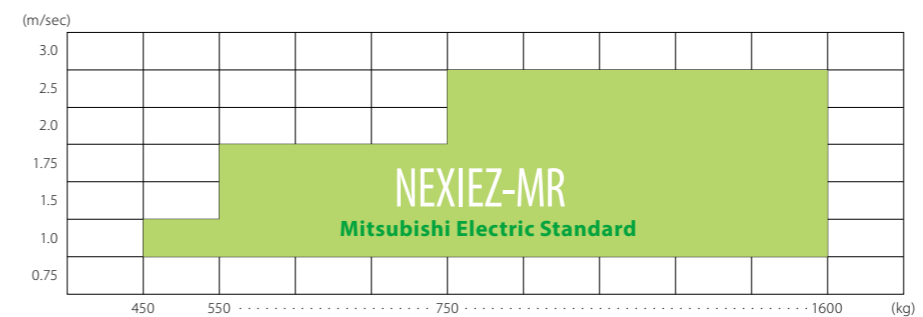

Welcome to a New Era in Vertical Transportation Introducing the NEXIEZ...

... technologically advanced elevators that consume less power, have minimal impact on the global environment and harmoniously serve people and buildings with smooth, seamless operation. The refined design produces a high-quality atmosphere that reassures passengers of the superior safety and comfort synonymous with Mitsubishi Electric products. Regardless of the use or purpose, the NEXIEZ is a best match solution for virtually any elevator installation.

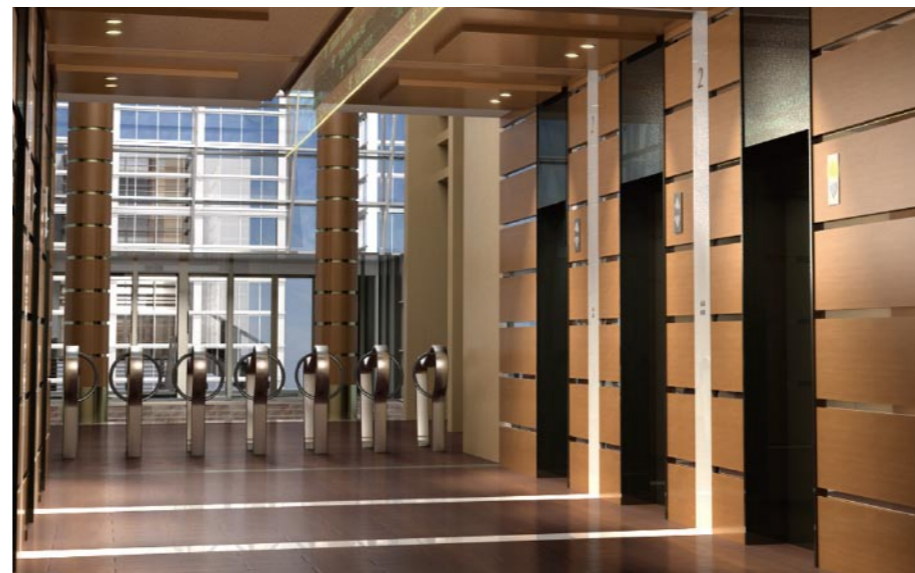



Ecology

Using Energy Wisely

Our long-term commitment to developing energy-efficient elevators has created systems and functions that make intelligent use of power.

Milestones of Energy-saving Technologies in Elevator Development

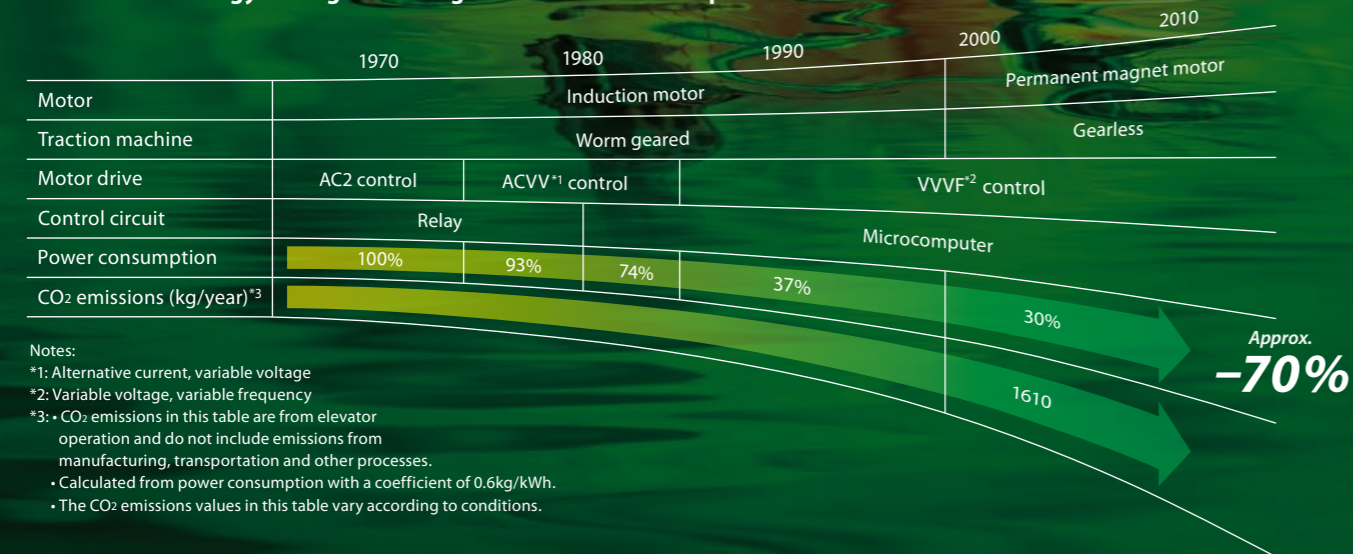

Reusing Energy

Regenerative Converter (PCNV) (Optional)

Elevators usually travel using power from a power supply (powered operation); however, when they travel down with a heavy car load or up with a light car load (regenerative operation), the traction machine functions as a power generator. Although the power generated during traction machine operation is usually dissipated as heat, the regenerative converter transmits the power back to the distribution transformer and feeds into the electrical network in the building along with electricity from the power supply. Compared to the same type of elevator without a regenerative converter, this system provides an energy-saving effect of up to 35%. (Reduction in CO₂ emissions: 1400 kg/year) In addition, the Regenerative Converter has the effect of decreasing harmonic currents.

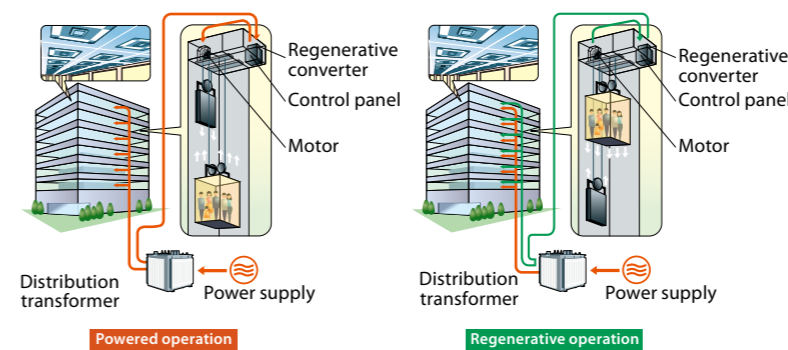

Enhancing Energy Efficiency

Traction Machine with PM Motor (PM motor: Permanent magnet motor)

The joint-lapped core built in the PM motor of the traction machine features flexible joints. The iron core can be like a hinge, which allows coils to be wound around the core more densely, resulting in improved motor efficiency and compactness. High-density magnetic field is produced, enabling lower use of energy and resources and reduced CO₂ emissions. In addition, we have adopted a 2:1 (single-wrap) roping system, which lessens load on the traction machine, and allows further reductions in traction machine size.

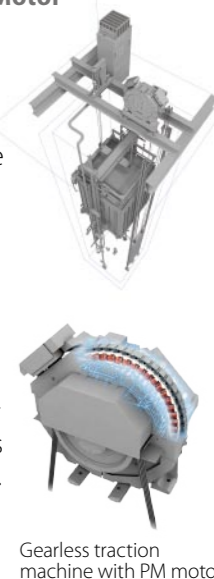

Devices that Use Less Energy

LED Lighting (Optional)

Energy-efficient LEDs consume less power than conventional lamps. Used for ceiling lights and hall lanterns, LEDs boost the overall energy performance of the building. Furthermore, the long service life eliminates the need for frequent lamp replacement.

Advantage of LEDs

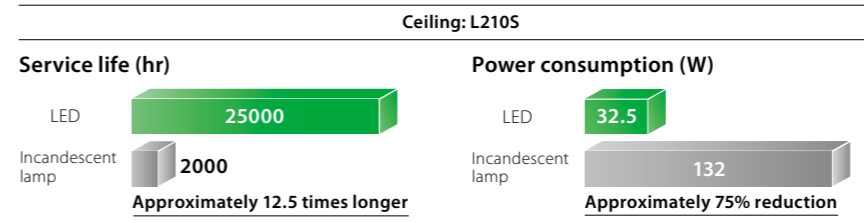

Ceiling: L210S LED downlights (yellow-orange)

Energy-saving Features

Mitsubishi Electric offers features that help to reduce the energy consumption of elevators.

Energy-saving Operation – Number of Cars (ESO-N) (Optional for ΣAI-22)

The number of service cars is automatically reduced to some extent without affecting passenger waiting time.

Energy-saving Operation – Allocation Control (ESO-W) (ΣAI-2200C only)

Based on each elevator's potential energy consumption, the system selects the elevator that best balances operational efficiency and energy consumption. Please refer to page 10 for details.

Car Light/Fan Shut Off – Automatic (CFO-A/CLO-A)

The car lighting/ventilation fan is automatically turned off if there are no calls for a specified period.

Smooth Mobility through Efficient Group Control

When a building is expected to have heavy traffic, optimum car allocation suited for every condition makes a big difference in preventing congestion at a lobby floor and reducing long waits.

Group Control Systems: ΣAI-22 and ΣAI-2200C
ΣAI-22 and ΣAI-2200C control multiple elevators optimally according to the building size.

Improving of traffic efficiency can alleviate the passengers' irritation. Applying the new allocation algorithm, the average waiting time and long waits are reduced.

Group control systems	Suitable building size	Number of cars in a group
ΣAI-22 system	Small to medium	3 to 4 cars
ΣAI-2200C system	Large (Especially buildings with dynamic traffic conditions)	3 to 8 cars

ΣAI-2200C Performance

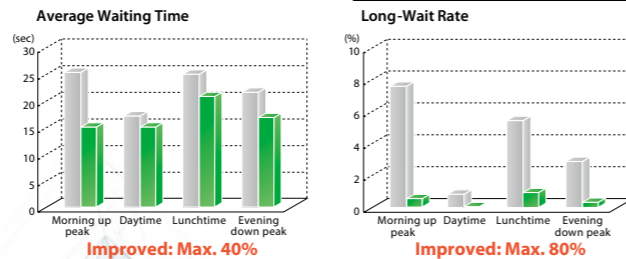

Forecasting a Near-Future Hall Call to Reduce Long Waits

Cooperative Optimization Assignment (ΣAI-2200C)

When a hall call is registered, the algorithm assumes a near-future call that could require long waits. Through evaluation of the registered hall call and the forecasted call, the best car is assigned. All cars work cooperatively for optimum operation.

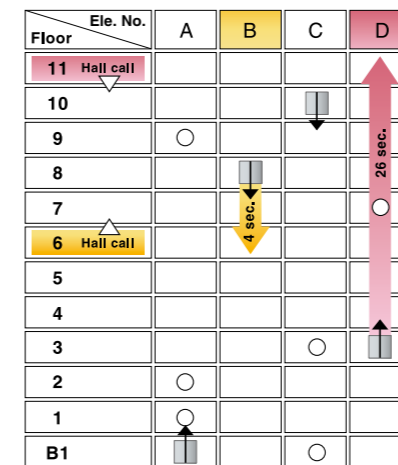
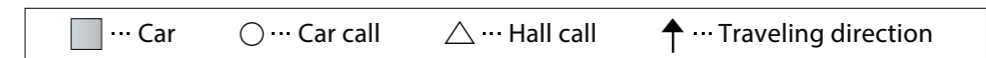

AI-2100N (Conventional system)
 [A hall call is registered at 6th Fl.]
 Allocates the closest car B.
 [Another hall call is soon registered at 11th Fl.]
 Allocates D, resulting in long wait of 26 sec.

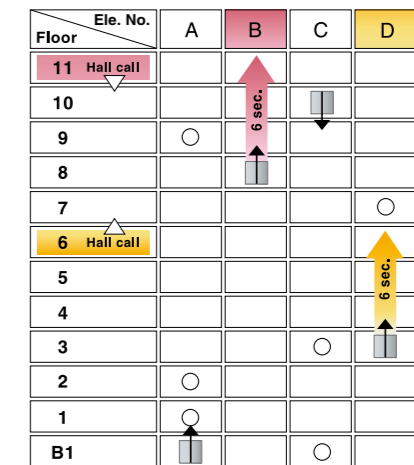

ΣAI-2200C (New)
 [A hall call is registered at 6th Fl.]
 Allocates D, which is moving upward.
 [Another hall call is soon registered at 11th Fl.]
 Allocates B, which immediately arrives at the floor.

Maximizing Operational Efficiency and Minimizing Energy Consumption

Energy-saving Operation — Allocation Control (ESO-W) (ΣAI-2200C)

This system selects the elevator in a group that best balances operational efficiency and energy consumption. Priority is given to operational efficiency during peak hours and energy efficiency during non-peak hours.

Car allocation that maximizes operational efficiency does not necessarily translate to energy efficiency. A car uses energy efficiently when it travels down with a heavy load, or up with a light load. Accordingly, if multiple cars have the same traveling distance, this system chooses the car that requires the least energy.

Through a maximum 10% reduction in energy consumption compared to our conventional system, this system allows building owners to cut energy costs without sacrificing passenger convenience.

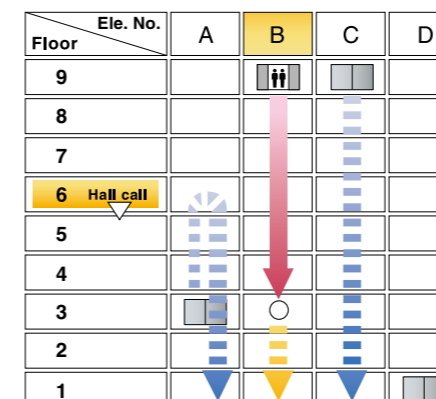

Initial conditions: non-peak period

- Car A:** Parked at the 3rd floor
- Car B:** About to leave the 9th floor with several passengers
- Car C:** Parked at the 9th floor.
- Car D:** Parked at the 1st floor

Under the conditions above, when a hall call is registered at the 6th floor to go to the 1st floor, waiting time and traveling distance will be the same regardless of whether car A, B or C responds to the call.

In response to the call, the cars will operate in the following ways:

- Car A will travel up with no passengers and then down with only one passenger (requires more energy than car B).
- Car B will travel down with more passengers than car A (requires the least energy).
- Car C will travel down with no passengers and then down with only one passenger (requires the most energy).

Car selection

During non-peak hours when energy efficiency is prioritized, car B is selected.

Selecting Optimum Car Allocation through Rule-set Simulations

Dynamic Rule-set Optimizer (ΣAI-2200C)

Based on real traffic data, passenger traffic is predicted every few minutes. According to the prediction, real-time simulation selects the best rule-set (multiple rules have been set as car allocation patterns), which optimizes transport efficiency.

Allocating Passengers to Cars Depending on Destination Floors

Destination Oriented Allocation System (DOAS) (ΣAI-2200C) (Optional)

When a passenger enters a destination floor at a hall, the hall operating panel immediately indicates which car will serve the floor. Because the destination floor is already registered, the passenger does not need to press a button in the car. Furthermore, dispersing passengers by destination prevents congestion in cars and minimizes their waiting and traveling time.

Standard arrangement (hall arrangement without hall lantern*)

Cars receive destination information from all floors to provide the best service for more complex traffic conditions throughout the day.

Example of hall arrangement

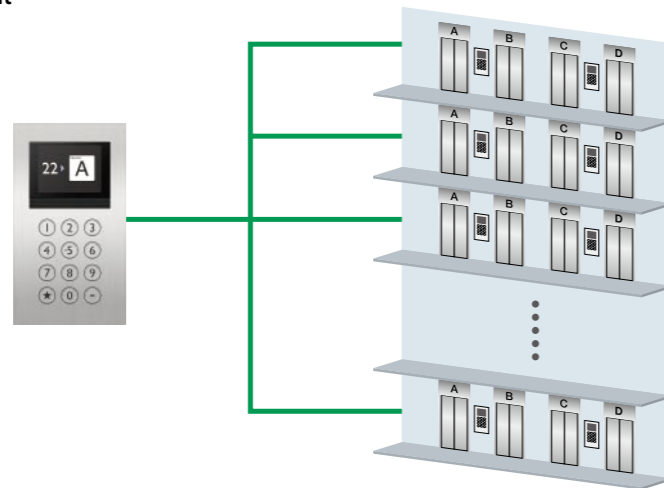

*Hall arrangement with hall lantern is available as an option.

Providing a Safe, Comfortable Ride

Whether the user is elderly or a person with special need, our elevators deliver every passenger to the destination floor safely and comfortably.

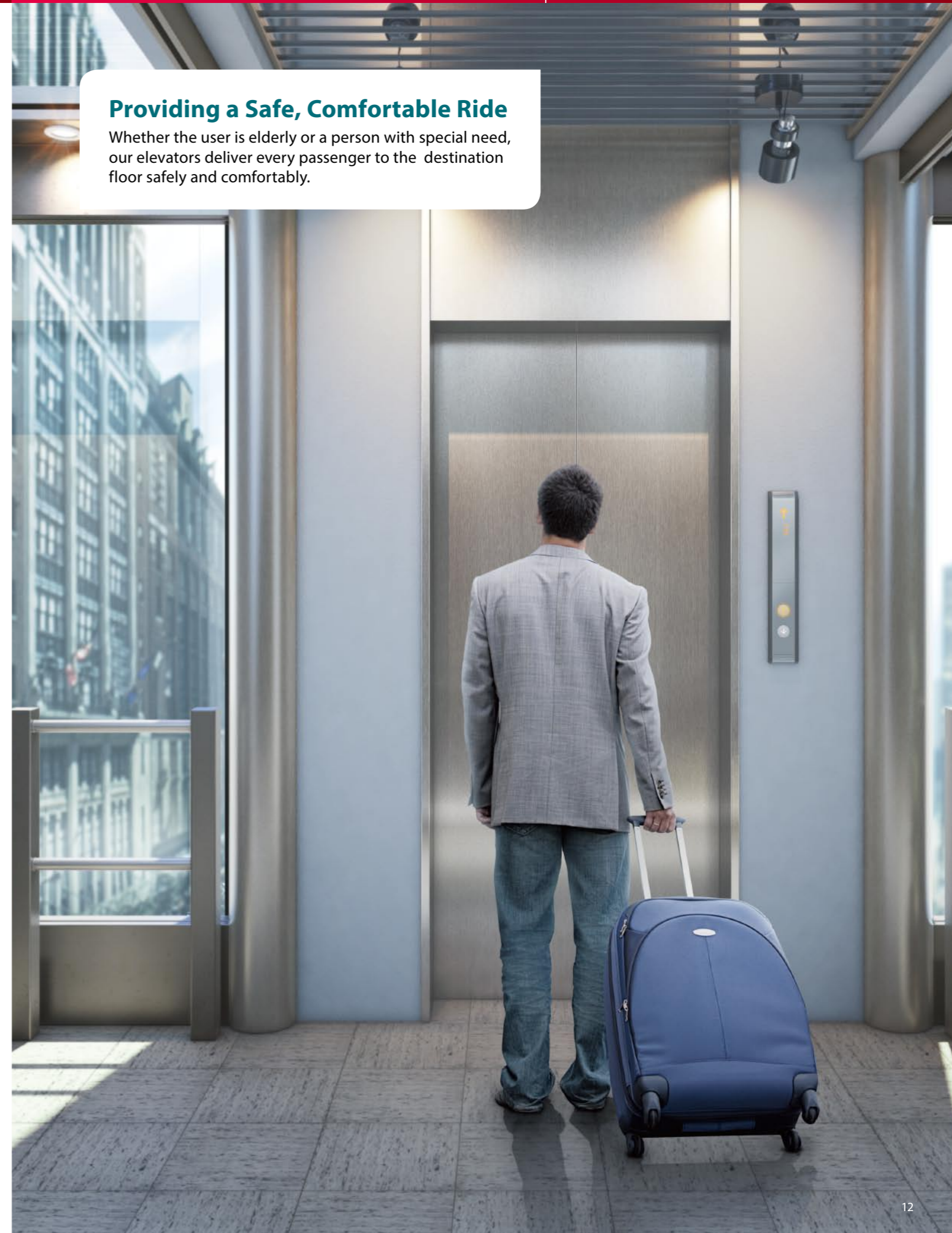

Emergency Situations

Emergency operations*

Enhance safety by adding emergency operation features which quickly respond to a power failure, fire or earthquake.

Power failure	Mitsubishi Emergency Landing Device (MELD) (Optional) Upon power failure, a car automatically moves to the nearest floor using a rechargeable battery to facilitate the safe evacuation of passengers.
	Operation by Emergency Power Source — Automatic/Manual (OEPS) (Optional) Upon power failure, predetermined car(s) use a building's emergency power supply to move to a specified floor and open the doors for passengers to evacuate. After all cars have arrived, predetermined car(s) will resume normal operation.
Fire	Fire Emergency Return (FER) (Optional) When a key switch or a building's fire sensors are activated, all cars immediately return to a specified floor and open the doors to facilitate the safe evacuation of passengers.
	Firefighters' Emergency Operation (FE) (Optional) When the fire operation switch is activated, the car immediately returns to a predetermined floor. The car then responds only to car calls which facilitate fire-fighting and rescue operations.
Earthquake	Earthquake Emergency Return (EER-P/EER-S) (Optional) When a primary and/or secondary wave seismic sensor is activated, all cars stop at the nearest floor and park there with the doors open to facilitate the safe evacuation of passengers.

*Please refer to page 16 for details.

For Safe Boarding

Door safety devices

Our reliable safety device ensures that the doors are clear to open and close. Depending on the type of sensor, the detection area differs.



Hall Motion Sensor (HMS)
(Optional)



Multi-beam Door Sensor
(Optional)

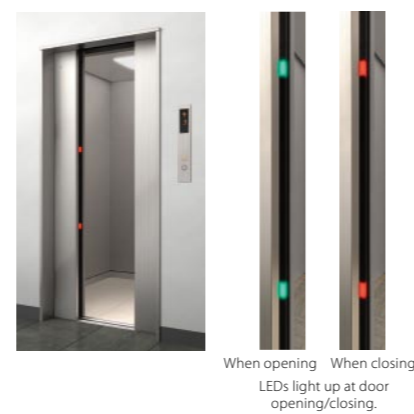

Multi-beam Door Sensor – Signal Type (MBSS)
(Optional)

When opening When closing
LEDs light up at door opening/closing.

For Comfortable Use

User-oriented Design

Great care is taken in the design and manufacture of each and every elevator part to ensure a comfortable, user-friendly ride.

Clear Font

The font for indicators and buttons is highly visible. On tactile buttons in particular, the font makes letters/numbers easy for visually-impaired passengers to distinguish.

1 2 3 4 5 6 7 8 9 0

LCD Position Indicators (Car/hall) (Optional)

Clear, bright LCD indicators deliver information clearly and effectively.

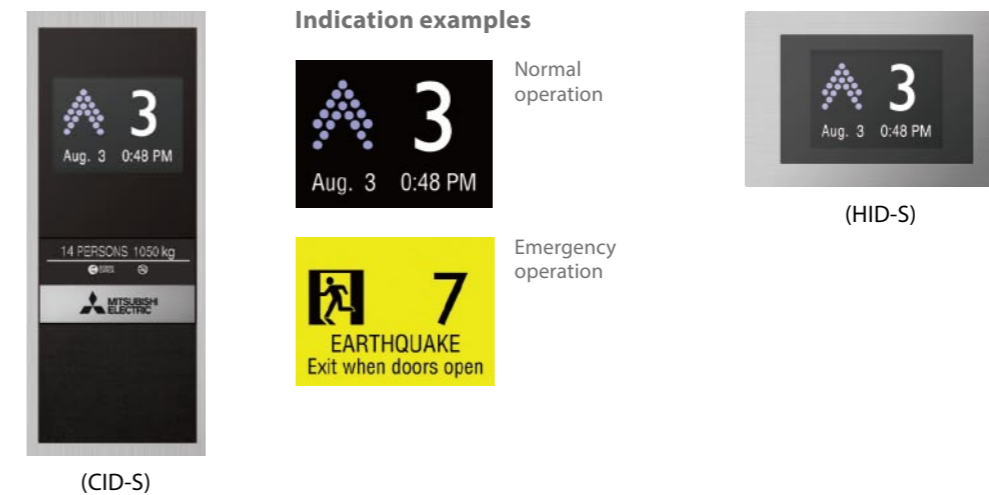

LCD Information Display*1 (10.4- or 15-inch, for car/hall) (Optional)

The cutting-edge LCD display delivers elevator information with stereoscopic direction arrows and animated pictures.



Colors

Select the best color from four popular and eye-catching background colors.



*1. Please consult our local agents for the production terms, etc.

Car

Ceiling: S00



Car Design Example

- Walls — SUS-HL
- Transom panel — SUS-HL
- Doors — SUS-HL
- Front return panels — SUS-HL
- Kickplate — Aluminum
- Flooring — PR803
- Car operating panel — CBV1-C760



Ceiling: Painted steel sheet (Y033) with a milky white resin lighting cover
Lighting: Central lighting

Car operating panel



CBV1-C760*1
Segment LED indicators*2
Tactile button with yellow-orange lighting

Hall position indicators and buttons

Metal-like resin faceplates



PIV1-A710N Boxless PIV1-A720N Boxless
Segment LED indicators*2
Tactile button with yellow-orange lighting

Hall

Narrow Jamb: E-102



Hall Design Example

- Jamb — SUS-HL
- Doors — SUS-HL
- Hall position indicator and button — PIV1-A710N Boxless

Notes:

*1: Maximum number of floors: 22 floors

*2: Some letters of the alphabets are not available. Please consult our local agents for details.

Feature	Description	1C-2BC	2C-2BC	3C to 4C ΣAI-22	3C to 8C ΣAI-2200C
EMERGENCY OPERATIONS AND FEATURES					
Mitsubishi Emergency Landing Device (MELD)	Upon power failure, a car equipped with this function automatically moves and stops at the nearest floor using a rechargeable battery, and the doors open to facilitate the safe evacuation of passengers. (Maximum allowable floor-to-floor distance is 11 meters.)	⊙	⊙	⊙	⊙
Operation by Emergency Power Source — Automatic/Manual (OEPS)	Upon power failure, predetermined car(s) use a building's emergency power supply to move to a specified floor, where the doors then open to facilitate the safe evacuation of passengers. After all cars have arrived, predetermined car(s) will resume normal operation.	⊙	⊙	⊙	⊙
Fire Emergency Return (FER)	Upon activation of a key switch or a building's fire sensors, all calls are canceled, all cars immediately return to a specified evacuation floor and the doors open to facilitate the safe evacuation of passengers.	⊙	⊙	⊙	⊙
Firefighters' Emergency Operation (FE)	During a fire, when the fire operation switch is activated, the car calls of a specified car and all hall calls are canceled and the car immediately returns to a predetermined floor. The car then responds only to car calls which facilitate fire-fighting and rescue operations.	⊙	⊙	⊙	⊙
Earthquake Emergency Return (EER-P/EER-S)	Upon activation of primary and/or secondary wave seismic sensors, all cars stop at the nearest floor, and park there with the doors open to facilitate the safe evacuation of passengers.	⊙	⊙	⊙	⊙
Supervisory Panel (WP)	Each elevator's status and operation can be remotely monitored and controlled through a panel installed in a building's supervisory room, etc.	⊙	⊙ ^{#1}	⊙	⊙ ^{#1}
MeEye (WP-W) Mitsubishi Elevators & Escalators Monitoring and Control System	Each elevator's status and operation can be monitored and controlled using an advanced Web-based technology which provides an interface through personal computers. Special optional features such as preparation of traffic statistics and analysis are also available.	⊙	⊙	⊙	⊙
Emergency Car Lighting (ECL)	Car lighting which turns on immediately when power fails, providing a minimum level of lighting within the car. (Choice of dry-cell battery or trickle-charge battery.)	⊙	⊙	⊙	⊙
DOOR OPERATION FEATURES					
Door Sensor Self-diagnosis (DODA)	Failure of non-contact door sensors is checked automatically, and if a problem is diagnosed, the door-close timing is delayed and the closing speed is reduced to maintain elevator service and ensure passenger safety.	Ⓢ	Ⓢ	Ⓢ	Ⓢ
Automatic Door Speed Control (DSAC)	Door load on each floor, which can depend on the type of hall door, is monitored to adjust the door speed, thereby making the door speed consistent throughout all floors.	Ⓢ	Ⓢ	Ⓢ	Ⓢ
Automatic Door-open Time Adjustment (DOT)	The time doors are open will automatically be adjusted, depending on whether the stop was called from the hall or the car, to allow smooth boarding of passengers or loading of baggage.	—	—	—	Ⓢ
Reopen with Hall Button (ROHB)	Closing doors can be reopened by pressing the hall button corresponding to the traveling direction of the car.	Ⓢ	Ⓢ	Ⓢ	Ⓢ
Repeated Door-close (RDC)	Should an obstacle prevent the doors from closing, the doors will repeatedly open and close until the obstacle is cleared from the doorway.	Ⓢ	Ⓢ	Ⓢ	Ⓢ
Door Nudging Feature — With Buzzer (NDG)	A buzzer sounds and the doors slowly close when they have remained open for longer than the preset period. With AAN-B or AAN-G, a beep and voice guidance sound instead of the buzzer.	Ⓢ	Ⓢ	Ⓢ	Ⓢ
Door Load Detector (DLD)	When excessive door load has been detected while opening or closing, the doors immediately reverse.	Ⓢ	Ⓢ	Ⓢ	Ⓢ
Safety Ray (SR)	1-Beam	Ⓢ	Ⓢ	Ⓢ	Ⓢ
	2-Beam	⊙	⊙	⊙	⊙
Extended Door-open Button (DKO-TB)	When the button inside a car is pressed, the doors will remain open longer to allow loading and unloading of baggage, a stretcher, etc.	⊙	⊙	⊙	—
Safety Door Edge (SDE)	One side	⊙	⊙	⊙	⊙
	Both sides (CO doors only)	⊙	⊙	⊙	⊙
Electronic Doorman (EDM)	Door open time is minimized using safety ray(s) or multi-beam door sensors that detect passengers boarding or exiting.	⊙	⊙	⊙	⊙
Multi-beam Door Sensor	Multiple infrared-light beams cover some 1800 mm in height of the doors as they close to detect passengers or objects. (Cannot be combined with the SR or MBSS feature.) Please refer to page 13.	⊙	⊙	⊙	⊙
Multi-beam Door Sensor — Signal Type (MBSS)	Multiple infrared-light beams cover a door height of approximately 1800mm to detect passengers or objects as the doors close. Additionally, LED lights on the door edge will indicate the door opening/closing and the presence of an obstacle between the doors. (Cannot be combined with any of the following features: SDE, SR or multi-beam door sensor.) Please refer to page 13.	⊙	⊙	⊙	⊙
Hall Motion Sensor (HMS)	Infrared-light is used to scan a 3D area near the open doors to detect passengers or objects. Please refer to page 13.	⊙	⊙	⊙	⊙

Notes: • 1C-2BC (1-car selective collective) - Standard, 2C-2BC (2-car group control system) - Optional, ΣAI-22 (3- and 4-car group control system) - Optional, ΣAI-2200C (3- to 8-car group control system) - Optional
• Ⓢ = Standard ⊙ = Optional — = Not applicable
• #1: Please consult our local agents for the production terms, etc.

Actual colors may differ slightly from those shown. Please refer to the design guide for details and other designs.

Features (2/2)

Feature	Description	1C-2BC	2C-2BC	3C to 4C ΣAI-22	3C to 8C ΣAI-2200C
■ OPERATIONAL AND SERVICE FEATURES					
Safe Landing (SFL)	If a car has stopped between floors due to some equipment malfunction, the controller checks the cause, and if it is considered safe to move the car, the car will move to the nearest floor at a low speed and the doors will open.	Ⓢ	Ⓢ	Ⓢ	Ⓢ
Next Landing (NLX)	If the elevator doors do not open fully at a destination floor, the doors close, and the car automatically moves to the next or nearest floor where the doors will open.	Ⓢ	Ⓢ	Ⓢ	Ⓢ
Continuity of Service (COS)	A car which is experiencing trouble is automatically withdrawn from group control operation to maintain overall group performance.	—	Ⓢ	Ⓢ	Ⓢ
Overload Holding Stop (OLH)	A buzzer sounds to alert the passengers that the car is overloaded. The doors remain open and the car will not leave that floor until enough passengers exit the car.	Ⓢ	Ⓢ	Ⓢ	Ⓢ
Automatic Hall Call Registration (FSAT)	If one car cannot carry all waiting passengers because it is full, another car will automatically be assigned for the remaining passengers.	Ⓢ	Ⓢ	Ⓢ	Ⓢ
Car Call Canceling (CCC)	When a car has responded to the final car call in one direction, the system regards remaining calls in the other direction as mistakes and clears them from the memory.	Ⓢ	Ⓢ	Ⓢ	Ⓢ
Car Fan Shut Off — Automatic (CFO-A)	If there are no calls for a specified period, the car ventilation fan will automatically turn off to conserve energy. Please refer to page 8.	Ⓢ	Ⓢ	Ⓢ	Ⓢ
Car Light Shut Off — Automatic (CLO-A)	If there are no calls for a specified period, the car lighting will automatically turn off to conserve energy. Please refer to page 8.	Ⓢ	Ⓢ	Ⓢ	Ⓢ
Backup Operation for Group Control Microprocessor (GCBK)	An operation by car controllers which automatically maintains elevator operation in the event that a microprocessor or transmission line in the group controller has failed.	—	Ⓢ	Ⓢ	Ⓢ
Independent Service (IND)	Exclusive operation where a car is withdrawn from group control operation for independent use, such as maintenance or repair, and responds only to car calls.	Ⓢ	Ⓢ	Ⓢ	Ⓢ
Automatic Bypass (ABP)	A fully-loaded car bypasses hall calls in order to maintain maximum operational efficiency.	Ⓢ	Ⓢ	Ⓢ	Ⓢ
False Call Canceling — Automatic (FCC-A)	If the number of registered car calls does not correspond to the car load, all calls are canceled to avoid unnecessary stops.	Ⓢ	Ⓢ	Ⓢ	Ⓢ
False Call Canceling — Car Button Type (FCC-P)	If the wrong car button is pressed, it can be canceled by quickly pressing the same button again twice.	Ⓢ	Ⓢ	Ⓢ	Ⓢ
Out-of-service-remote (RCS)	With a key switch on the supervisory panel, etc., a car can be called to a specified floor after responding to all car calls, and then automatically be taken out of service.	Ⓢ	Ⓢ	Ⓢ	Ⓢ
Non-service Temporary Release for Car Call — Card Reader Type (NSCR-C)	To enhance security, car calls for desired floors can be registered only by placing a card over a card reader. This function is automatically deactivated during emergency operation.	Ⓢ	Ⓢ	Ⓢ	Ⓢ
Secret Call Service (SCS-B)	To enhance security, car calls for desired floors can be registered only by entering secret codes using the car buttons on the car operating panel. This function is automatically deactivated during emergency operation.	Ⓢ	Ⓢ	Ⓢ	Ⓢ
Non-service to Specific Floors — Car Button Type (NS-CB)	To enhance security, service to specific floors can be disabled using the car operating panel. This function is automatically deactivated during emergency operation.	Ⓢ	Ⓢ	Ⓢ	Ⓢ
Non-service to Specific Floors — Switch/Timer Type (NS/NS-T)	To enhance security, service to specific floors can be disabled using a manual or timer switch. This function is automatically deactivated during emergency operation.	Ⓢ	Ⓢ ^{#1}	Ⓢ	Ⓢ
Out-of-service by Hall Key Switch (HOS/HOS-T)	For maintenance or energy-saving measures, a car can be taken out of service temporarily with a key switch (with or without a timer) mounted in a specified hall.	Ⓢ	Ⓢ	Ⓢ	Ⓢ
Return Operation (RET)	Using a key switch on the supervisory panel, a car can be withdrawn from group control operation and called to a specified floor. The car will park on that floor with the doors open, and not accept any calls until independent operations begin.	Ⓢ	Ⓢ	Ⓢ	Ⓢ
Attendant Service (AS)	Exclusive operation where an elevator can be operated using the buttons and switches located in the car operating panel, allowing smooth boarding of passengers or loading of baggage.	Ⓢ	Ⓢ	Ⓢ	Ⓢ
Regenerative Converter (PCNV)	For energy conservation, power regenerated by a traction machine can be used by other electrical systems in the building. Please refer to page 8.	Ⓢ	Ⓢ	Ⓢ	Ⓢ
■ GROUP CONTROL FEATURES					
Energy-saving Operation — Number of Cars (ESO-N)	To save energy, the number of service cars is automatically reduced to some extent, but not so much that it adversely affects passenger waiting time. Please refer to page 8.	—	—	Ⓢ	Ⓢ
Destination Oriented Allocation System (DOAS)	When a passenger enters a destination floor at a hall, the hall operating panel indicates which car will serve the floor. The passenger does not need to press a button in the car. Dispersing passengers by destination prevents congestion in the cars and minimizes waiting and traveling time. (Cannot be combined with some features. Please consult our local agents for details.) Please refer to page 11.	—	—	—	Ⓢ ^{#2}
Intense Up Peak (IUP)	To maximize transport efficiency, an elevator bank is divided into two groups of cars to serve upper and lower floors separately during up peak. In addition, the number of cars to be allocated, the timing of car allocation to the lobby floor, the timing of door closing, etc. are controlled based on predicted traffic data.	—	—	—	Ⓢ
Up Peak Service (UPS)	Controls the number of cars to be allocated to the lobby floor, as well as the car allocation timing, in order to meet increased demands for upward travel from the lobby floor during office starting time, hotel check-in time, etc., and minimize passenger waiting time.	—	—	Ⓢ	Ⓢ
Down Peak Service (DPS)	Controls the number of cars to be allocated and the timing of car allocation in order to meet increased demands for downward travel during office leaving time, hotel check-out time, etc. to minimize passenger waiting time.	—	—	Ⓢ	Ⓢ

Feature	Description	1C-2BC	2C-2BC	3C to 4C ΣAI-22	3C to 8C ΣAI-2200C
Forced Floor Stop (FFS)	All cars in a bank automatically make a stop at a predetermined floor on every trip without being called.	Ⓢ	Ⓢ	Ⓢ	Ⓢ
Main Floor Parking (MFP)	An available car always parks on the main (lobby) floor with the doors open/closed (China only).	Ⓢ	Ⓢ	Ⓢ	Ⓢ
Special Floor Priority Service (SFPS)	Special floors, such as floors with VIP rooms or executive rooms, are given higher priority for car allocation when a call is made on those floors. (Cannot be combined with hall position indicators.)	—	—	Ⓢ ^{#1}	Ⓢ
Closest-car Priority Service (CNPS)	A function to give priority allocation to the car closest to the floor where a hall call button has been pressed, or to reverse the closing doors of the car closest to the pressed hall call button on that floor. (Cannot be combined with hall position indicators.)	—	—	Ⓢ ^{#1}	Ⓢ
Light-load Car Priority Service (UCPS)	When traffic is light, empty or lightly-loaded cars are given higher priority to respond to hall calls in order to minimize passenger travel time. (Cannot be combined with hall position indicators.)	—	—	Ⓢ ^{#1}	Ⓢ
Special Car Priority Service (SCPS)	Special cars, such as observation elevators and elevators with basement service, are given higher priority to respond to hall calls. (Cannot be combined with hall position indicators.)	—	—	Ⓢ ^{#1}	Ⓢ
Congested-floor Service (CFS)	The timing of car allocation and the number of cars to be allocated to floors where meeting rooms or ballrooms exist and the traffic intensifies for short periods of time are controlled according to the detected traffic density data for those floors.	—	—	Ⓢ	Ⓢ
Bank-separation Operation (BSO)	Hall buttons and the cars called by each button can be divided into several groups for independent group control operation to serve special needs or different floors.	—	Ⓢ ^{#1}	Ⓢ	Ⓢ
VIP Operation (VIP-S)	A specified car is withdrawn from group control operation for VIP service operation. When activated, the car responds only to existing car calls, moves to a specified floor and parks there with the doors open. The car will then respond only to car calls.	—	Ⓢ ^{#1}	Ⓢ	Ⓢ
Lunchtime Service (LTS)	During the first half of lunchtime, calls for a restaurant floor are served with higher priority, and during the latter half, the number of cars allocated to the restaurant floor, the allocation timing for each car and the door opening and closing timing are all controlled based on predicted data.	—	—	Ⓢ	Ⓢ
Main Floor Changeover Operation (TFS)	This feature is effective for buildings with two main (lobby) floors. The floor designated as the "main floor" in a group control operation can be changed as necessary using a manual switch.	Ⓢ	Ⓢ	Ⓢ	Ⓢ
■ SIGNAL AND DISPLAY FEATURES					
Flashing Hall Lantern (FHL)	A hall lantern, which corresponds to a car's service direction, flashes to indicate that the car will soon arrive.	Ⓢ	Ⓢ	Ⓢ	Ⓢ
Basic Announcement (AAN-B)	A synthetic voice (and/or buzzer) alerts passengers inside a car that elevator operation has been temporarily interrupted by overloading or a similar cause. (Voice only available in English.)	Ⓢ	Ⓢ	Ⓢ	Ⓢ
Car Arrival Chime	Car (AECC)	Ⓢ	Ⓢ	Ⓢ	—
	Hall (AECH)	Ⓢ	Ⓢ	Ⓢ	Ⓢ
Sonic Car Button — Click Type (ACB)	A click-type car button which emits electronic beep sounds when pressed to indicate that the call has been registered.	Ⓢ	Ⓢ	Ⓢ	Ⓢ
Immediate Prediction Indication (AIL)	When a passenger has registered a hall call, the best car to respond to that call is immediately selected, the corresponding hall lantern lights up and a chime sounds once to indicate which doors will open.	—	—	Ⓢ	Ⓢ
Second Car Prediction (TCP)	When a hall is crowded to the extent that one car cannot accommodate all waiting passengers, the hall lantern will light up to indicate the next car to serve the hall.	—	—	—	Ⓢ
Voice Guidance System (AAN-G)	Information on elevator service such as the current floor or service direction is given to the passengers inside a car. (Voice guidance available in English, Chinese and Spanish.)	Ⓢ	Ⓢ	Ⓢ	Ⓢ
Auxiliary Car Operating Panel (ACS)	An additional car control panel which can be installed for large-capacity elevators, heavy-traffic elevators, etc.	Ⓢ	Ⓢ	Ⓢ	Ⓢ
Inter-communication System (ITP)	A system which allows communication between passengers inside a car and the building personnel.	Ⓢ	Ⓢ	Ⓢ	Ⓢ
Car LCD Position Indicator (CID-S)	This 5.7-inch LCD for car operating panels shows the date and time, car position, travel direction and elevator status messages.	Ⓢ	Ⓢ	Ⓢ	Ⓢ
Hall LCD Position Indicator (HID-S)	This 5.7-inch LCD for elevator halls shows the date and time, car position, travel direction and elevator status messages.	Ⓢ	Ⓢ	Ⓢ	—
Car Information Display (CID)	This LCD (10.4- or 15-inch) for car front return panels shows the date and time, car position, travel direction and elevator status messages.	Ⓢ	Ⓢ	Ⓢ	Ⓢ
Hall Information Display (HID)	This LCD (10.4- or 15-inch) for elevator halls shows the date and time, car position, travel direction and elevator status messages.	Ⓢ	Ⓢ	Ⓢ	—

Notes: • 1C-2BC (1-car selective collective) - Standard, 2C-2BC (2-car group control system) - Optional, ΣAI-22 (3- to 8-car group control system) - Optional, ΣAI-2200C (3- to 8-car group control system) - Optional
 • Ⓢ = Standard Ⓢ = Optional — = Not applicable
 • #1: Please consult our local agents for the production terms, etc.
 • #2: When DOAS is applied, SR or multi-beam door sensor should be installed.

Horizontal Dimensions

Mitsubishi Electric Standard									
Code number	Number of persons	Rated capacity (kg)	Rated speed (m/sec)	Door type	Entrance width (mm) JJ	Car internal dimensions (mm) AA×BB	Counterweight position	Minimum hoistway dimensions (mm) AH×BH/car	Minimum machine room dimensions (mm) AM×BM/car
P6	6	450	1.0	CO	800	1400×850	Rear	1750×1400	1850×2700
P8	8	550	1.0				Side	2100×1200	2100×1900
P9	9	600					1.5	Rear	1750×1590
P10	10	700				1.75	Side	2100×1380	2100×2000
P11	11	750	1.0			Rear	1750×1660	1850×2950	
						Side	2100×1450	2100×2050	
						Rear	1750×1810	1850×3100	
P13	13	900	1.5			Side	2100×1600	2100×2050	
						Rear	1750×1910	1850×3200	
						Side	2100×1700	2100×2100	
P15	15	1000	1.75			Rear	2000×1910	2000×1950	
						Side	2400×1730	2400×2150	
						Rear	2000×2060	2000×2100	
P17	17	1150	2.0			Side	2400×1880	2400×2200	
						Rear	2200×1860	2200×1900	
				Side	2600×1680	2600×2100			
P20	20	1350	2.5	Rear	1850×2530	1850×2530			
				Side	2200×2110	2200×2150			
				Rear	2600×1880	2600×2200			
P24	24	1600	2.5	Rear	2400×1960	2400×2000			
				Side	2800×1730	2800×2150			
				Rear	2200×2310	2200×2350			
2S	1200	1400×2400	2.5	Side	2600×2080	2600×2300			
				Rear	2400×2160	2400×2200			
				Side	2800×1930	2800×2300			
2S	1200	1400×2400	2.5	Rear	2500×2250	2500×2250			
				Side	2880×1980	2880×1980			
				Side	2180×2830	2180×2830			

- [Terms of the table]
- The contents of this table are applied to standard specifications only. Please consult our local agents for other specifications.
 - Rated capacity is calculated as 65kg per person, as required by the Building Standard Law of Japan, 2009.
 - CO: 2-panel center opening doors, 2S: 2-panel side sliding doors.
 - Minimum hoistway dimensions (AH and BH) shown in the table are after waterproofing of the pit and do not include plumb tolerance. Dimensions AH and BH for rated speed 2.5 m/sec in a single hoistway is different from the above table to prevent a wind noise. Please consult our local agents for details.
 - This table shows the specifications without the fireproof landing door and counterweight safety.

Hoistway Plan

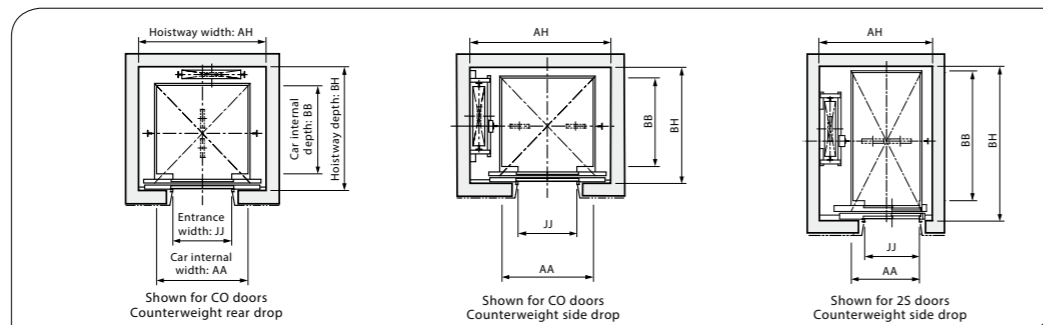

Machine Room Plan Example

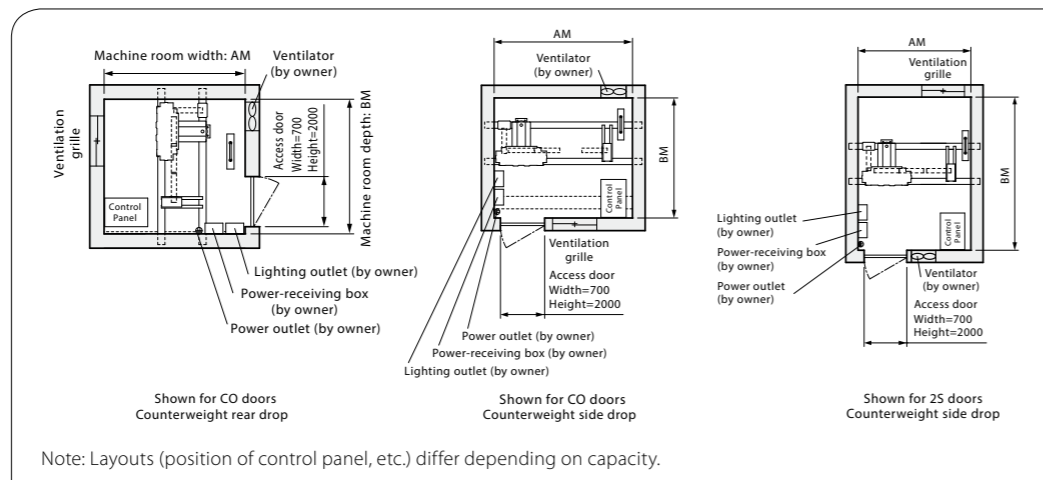

Vertical Dimensions

Mitsubishi Electric Standard									
Rated speed (m/sec)	Rated capacity (kg)	Maximum travel (m) TR	Maximum number of stops	Minimum overhead (mm) OH		Minimum pit depth (mm) PD		Minimum machine room clear height (mm) HM	Minimum floor to floor height (mm)
				TR≤80	80<TR≤120	TR≤90	90<TR		
1.0	450≤Capacity≤1600	60	30	4400		1360		2200	2500 ^{*2}
1.5	550≤Capacity≤1600	90		4560		1410			
1.75				4630		1410			
2.0	750≤Capacity≤1350	120 ^{*1}	36	4720	4820	1550	1650		
	1350<Capacity≤1600	90	30						
2.5	750≤Capacity≤1350	120 ^{*1}	36	4950	5050	1900	2000		
	1350<Capacity≤1600	90	30						

- [Terms of the table]
- The contents of this table are applied only to standard specifications without counterweight safety. Please consult our local agents for other specifications.
- [Note]
- *1 Maximum travel is 90m when the counterweight is installed in a side drop position.
 - *2 Some specifications require more than 2500mm as a minimum floor height. Please consult our local agents if the floor height is less than entrance height HH + 700mm.

Elevation

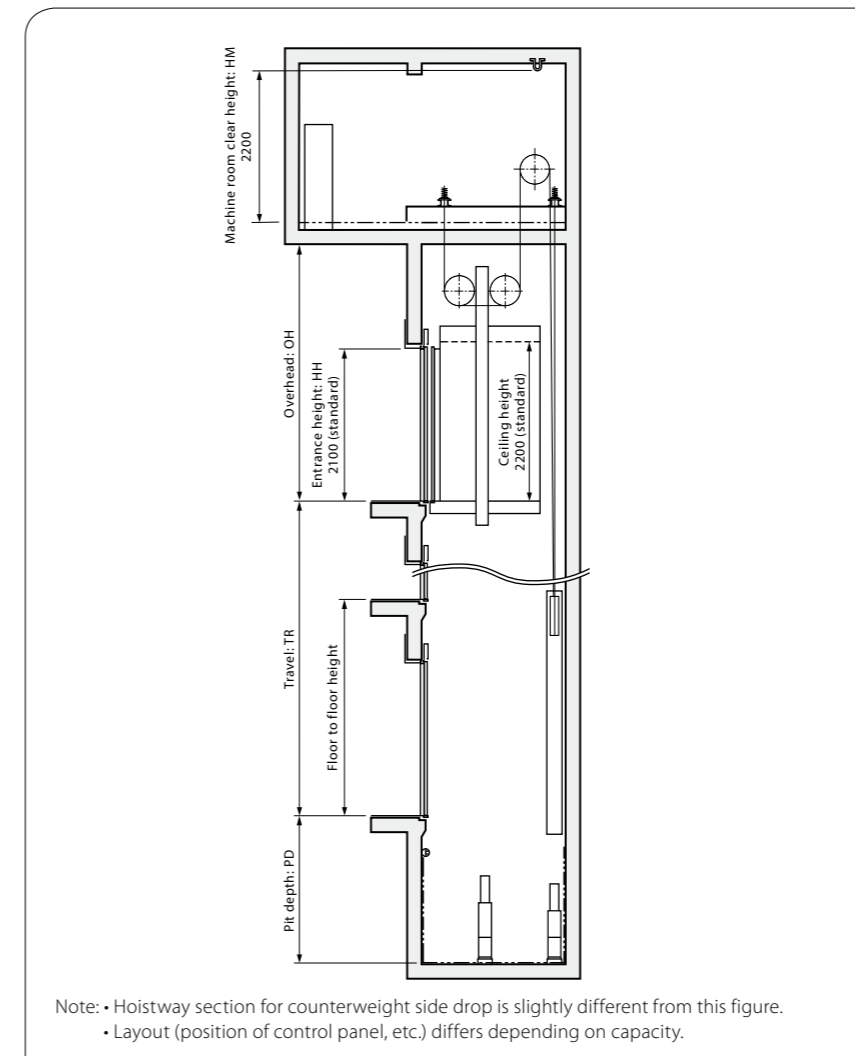

Applicable Standards

NEXIEZ-MR complies with Mitsubishi Electric standard*. For details of compliance, please consult our local agents.

* Based on, but not fully complying with the Building Standard Law of Japan, 2009.

Horizontal Dimensions

EN81-1									
Code number	Number of persons	Rated capacity (kg)	Rated speed (m/sec)	Door type	Entrance width (mm) JJ	Car internal dimensions (mm) AA×BB	Counterweight position	Minimum hoistway dimensions (mm) AH×BH/car	Minimum machine room dimensions (mm) AM×BM/car
P11	11	825	1.0 1.6 1.75 2.0 2.5	CO	900	1400×1350	Rear	1950×1930	1970×1930
P14	14	1050					Side	2210×1700	2210×1900
				CO		Rear	2000×1980	2000×1980	
P17	17	1275				Side	2410×1740	2410×1910	
				2S		Side	1910×2510	1910×2510	
P18	18	1350				CO	1100	Rear	2400×2030
			CO	Side	2820×1740	2820×1940			
2S	Side	2020×2680		2020×2680					
	CO	Rear	2400×2130	2400×2130					
2S		Side	2820×1840	2820×1990					

[Terms of the table]

- The contents of this table are applied to standard specifications only. Please consult our local agents for other specifications.
- Rated capacity is calculated as 75kg per person, as required by EN81-1.
- CO: 2-panel center opening doors, 2S: 2-panel side sliding doors.
- Minimum hoistway dimensions (AH and BH) shown in the table are after waterproofing of the pit and do not include plumb tolerance. Dimensions AH and BH for rated speed 2.5 m/sec in a single hoistway is different from the above table to prevent a wind noise. Please consult our local agents for details.
- This table shows the specifications without the fireproof landing door and counterweight safety.

Hoistway Plan

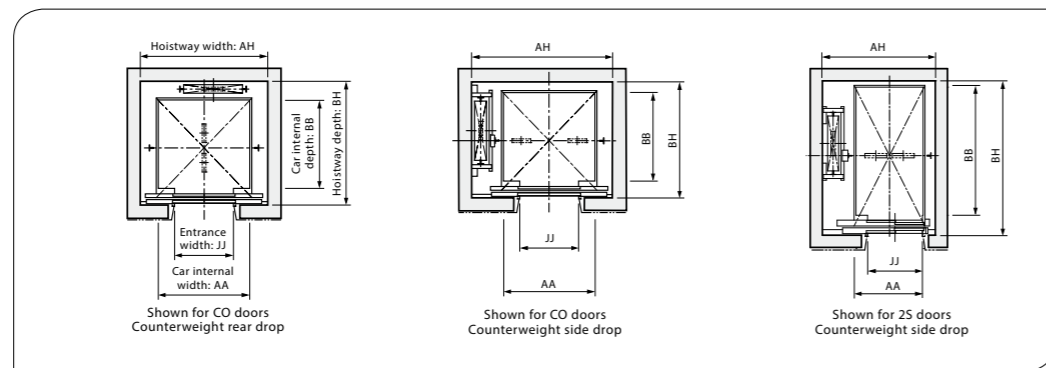

Machine Room Plan Example

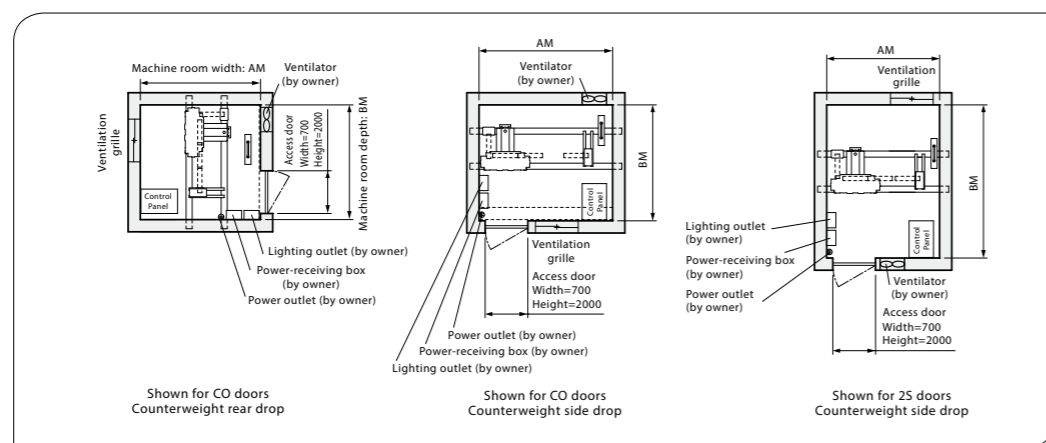

Vertical Dimensions

EN81-1								
Rated speed (m/sec)	Rated capacity (kg)	Maximum travel (m) TR	Maximum number of stops	Minimum overhead (mm) OH		Minimum pit depth (mm) PD		Minimum machine room clear height (mm) HM
				TR≤90	90<TR≤120	Code number P11 and P14	Code number P17 and P18	
1.0	825≤Capacity≤1350	60	30	4400		1360	1520	2250
1.6		90		4560		1410	1560	
1.75				4630		1430	1590	
2.0	825≤Capacity≤1050	90	30	4720	4820	1550	1650	
	1050<Capacity≤1350	120 ^{*1}	36					
2.5	825≤Capacity≤1050	90	30	4950	5050	1900	1900	
	1050<Capacity≤1350	120 ^{*1}	36					

[Terms of the table]

- The contents of this table are applied only to standard specifications without counterweight safety. Please consult our local agents for other specifications.

[Note]

*1 Maximum travel is 90m when the counterweight is installed in a side drop position.

*2 Some specifications require more than 2500mm as a minimum floor height. Please consult our local agents if the floor height is less than entrance height HH + 700mm.

Elevation

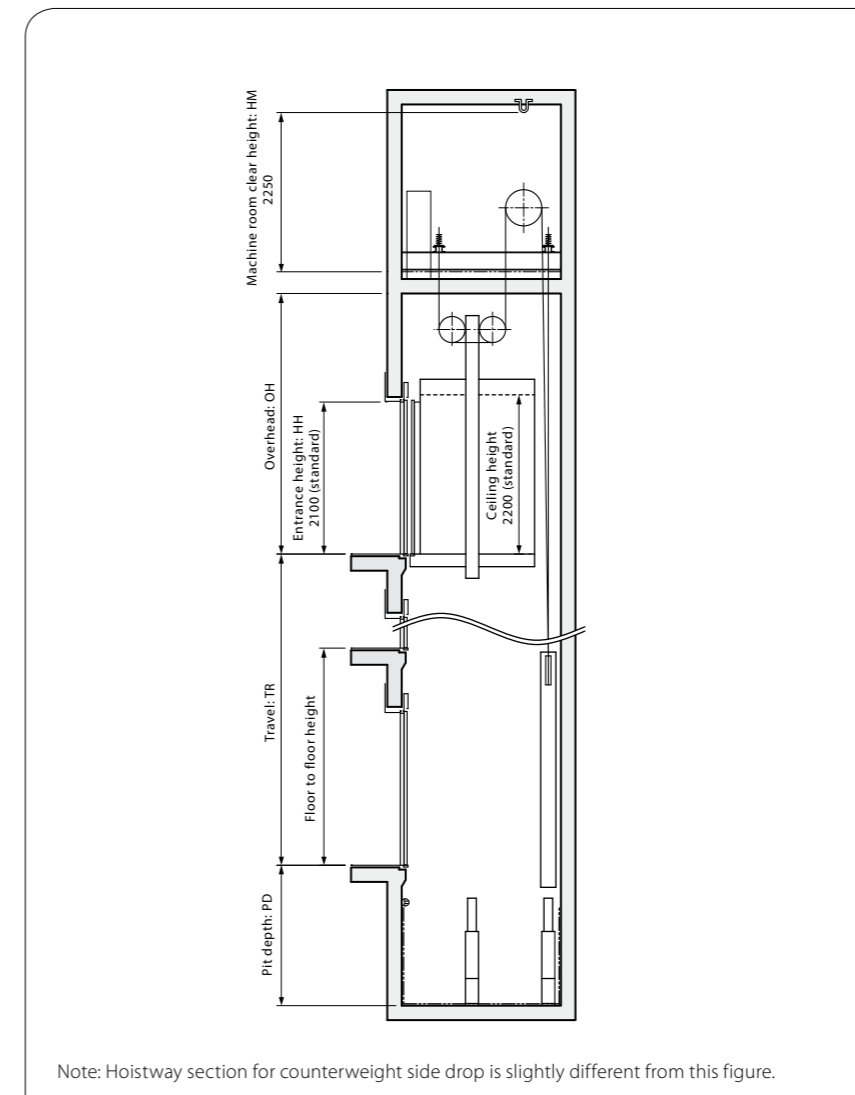

Applicable Standards

NEXIEZ-MR complies with EN81-1.

Horizontal Dimensions

GB7588									
Code number	Number of persons	Rated capacity (kg)	Rated speed (m/sec)	Door type	Entrance width (mm) JJ	Car internal dimensions (mm) AA×BB	Counterweight position	Minimum hoistway dimensions (mm) AH×BH/car	Minimum machine room dimensions (mm) AM×BM/car
P10	10	750	1.0 1.6 1.75 2.0 2.5	CO	900	1400×1300	Rear	1950×1880	1970×1880
P11	11	825					Side	2190×1680	2190×1900
P12	12	900				Rear	1950×1930	1970×1930	
						Side	2210×1700	2210×1900	
P14	14	1050				Rear	2000×1910	2000×1910	
						Side	2410×1690	2410×1900	
P16	16	1200				Rear	2000×1980	2000×1980	
						Side	2410×1740	2410×1910	
P17	17	1275				Rear	2200×1930	2200×1930	
				Side	2610×1700	2610×1900			
P18	18	1350		Rear	2000×2080	2000×2080			
				Side	2410×1840	2410×1960			
CO	1000	1800×1350		Rear	1910×2510	1910×2510			
				Side	2200×2130	2200×2130			
		2000×1350		Rear	2620×1840	2620×1990			
				Side	2400×1980	2400×1980			
		2000×1400		Rear	2820×1700	2820×1930			
				Side	2400×2030	2400×2030			
		1200×2300	Rear	2820×1740	2820×1940				
			Side	2020×2680	2020×2680				
		2000×1500	Rear	2400×2130	2400×2130				
Side	2820×1840		2820×1990						
CO	1000	1800×1680	Rear	2200×2310	2200×2310				
			Side	2620×2020	2620×2080				
		2S	1100×2100						

- [Terms of the table]
- The contents of this table are applied to standard specifications only. Please consult our local agents for other specifications.
 - Rated capacity is calculated as 75kg per person, as required by GB7588.
 - CO: 2-panel center opening doors, 2S: 2-panel side sliding doors.
 - Minimum hoistway dimensions (AH and BH) shown in the table are after waterproofing of the pit and do not include plumb tolerance. Dimensions AH and BH for rated speed 2.5 m/sec in a single hoistway is different from the above table to prevent a wind noise. Please consult our local agents for details.
 - This table shows the specifications without the fireproof landing door and counterweight safety.

Hoistway Plan

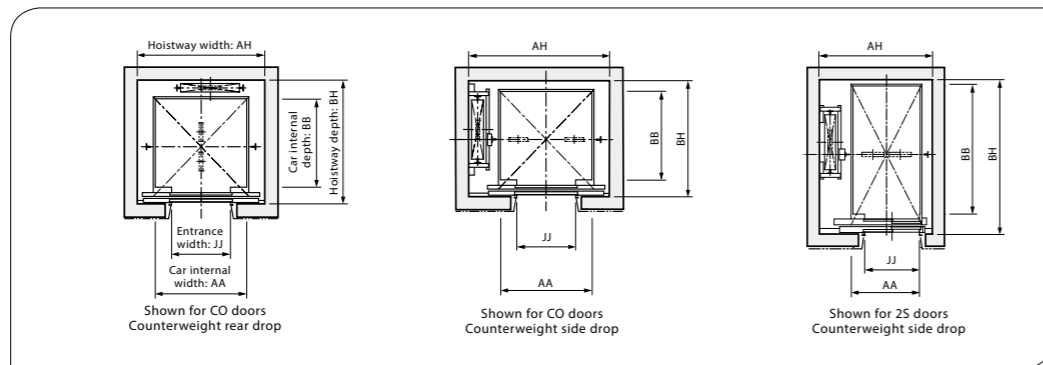

Machine Room Plan Example

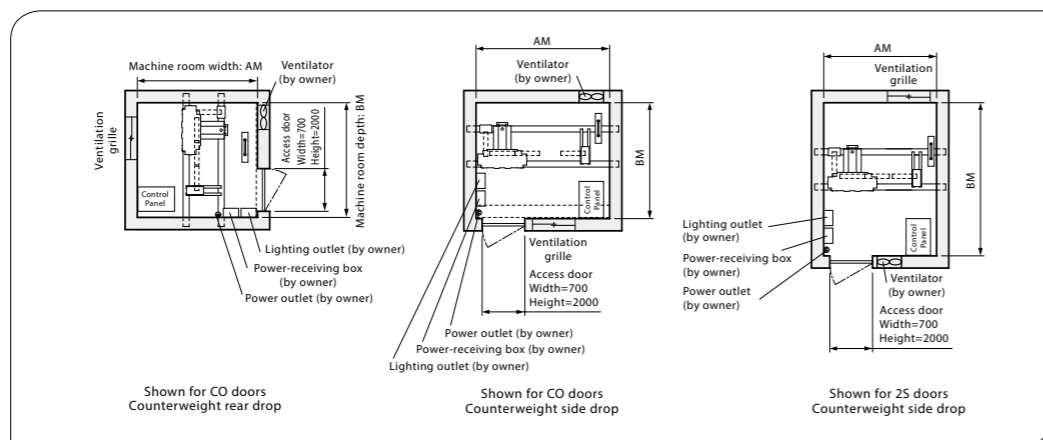

Vertical Dimensions

GB7588									
Rated speed (m/sec)	Rated capacity (kg)	Maximum travel (m) TR	Maximum number of stops	Minimum overhead (mm) OH		Minimum pit depth (mm) PD		Minimum machine room clear height (mm) HM	Minimum floor to floor height (mm)
				TR≤90	90<TR≤120	Code number P10-P12 and P14	Code number P16-P18		
1.0	750≤Capacity≤1350	60	30	4400		1360	1520	2250	2500 ^{*2}
1.6		90		4560		1410	1560		
1.75				4630		1430	1590		
2.0	750≤Capacity≤1050	90	30	4720	4820	1550	1650		
	1050<Capacity≤1350	120 ^{*1}	36						
2.5	750≤Capacity≤1050	90	30	4950	5050	1900	1900		
	1050<Capacity≤1350	120 ^{*1}	36						

- [Terms of the table]
- The contents of this table are applied only to standard specifications without counterweight safety. Please consult our local agents for other specifications.
 - [Note]
 - *1 Maximum travel is 90m when the counterweight is installed in a side drop position.
 - *2 Some specifications require more than 2500mm as a minimum floor height. Please consult our local agents if the floor height is less than entrance height HH + 700mm.

Elevation

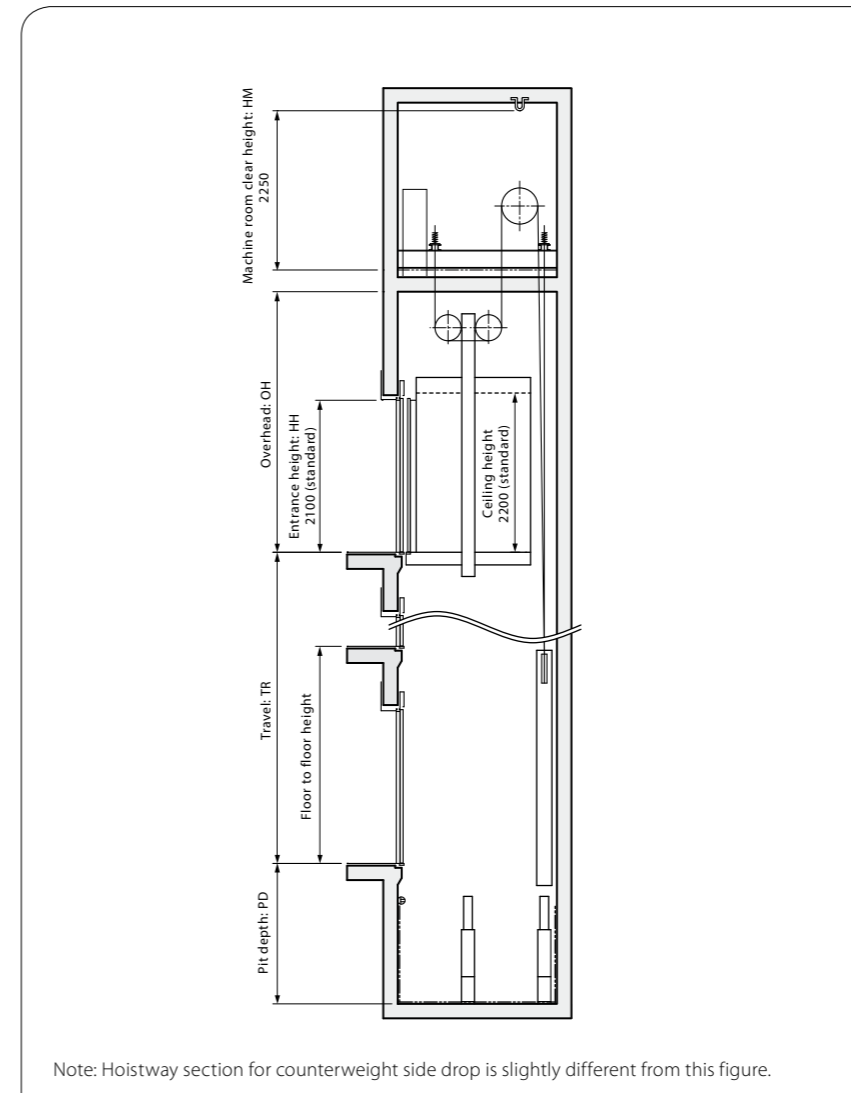

Applicable Standards

NEXIEZ-MR complies with GB7588.

Important Information on Elevator Planning

Work Not Included in Elevator Contract

The following items are excluded from Mitsubishi Electric's elevator installation work, and are therefore the responsibility of the building owner or general contractor:

- Construction of the elevator machine room with proper beams and slabs, equipped with a lock, complete with illumination, ventilation and waterproofing.
- Access to the elevator machine room sufficient to allow passage of the control panel and traction machine.
- Architectural finishing of the machine room floor, and the walls and floors in the vicinity of the entrance hall after installation has been completed.
- Construction of an illuminated, ventilated and waterproofed elevator hoistway.
- A ladder to the elevator pit.
- The provision of cutting the necessary openings and joists.
- Separate beams, when the hoistway dimensions markedly exceed the specifications, and intermediate beams when two or more elevators are installed.
- All other work related to building construction.
- The machine room power-receiving panel and the electrical wiring for illumination, plus the electrical wiring from the electrical room to the power-receiving panel.
- The laying of conduits and wiring between the elevator pit and the terminating point for the devices installed outside the hoistway, such as the emergency bell, intercom, monitoring and security devices, etc.
- The power consumed in installation work and test operations.
- All the necessary building materials for grouting in of brackets, bolts, etc.
- The test provision and subsequent alteration as required, and eventual removal of the scaffolding as required by the elevator contractor, and any other protection of the work as may be required during the process.
- The provision of a suitable, locked space for the storage of elevator equipment and tools during elevator installation.
- The security system, such as a card reader, connected to Mitsubishi Electric's elevator controller, when supplied by the building owner or general contractor.

* Work responsibilities in installation and construction shall be determined according to local laws. Please consult our local agents for details.

Elevator Site Requirements

- The temperature of the machine room and elevator hoistway shall be below 40°C.
- The following conditions are required for maintaining elevator performance.
 - a. The relative humidity shall be below 90% on a monthly average and below 95% on a daily average.
 - b. Prevention shall be provided against icing and condensation occurring due to a rapid drop in the temperature in the machine room and elevator hoistway.
 - c. The machine room and the elevator hoistway shall be finished with mortar or other materials so as to prevent concrete dust.
- Voltage fluctuation shall be within a range of +5% to -10%.

Ordering Information

Please include the following information when ordering or requesting estimates:

- The desired number of units, speed and loading capacity.
- The number of stops or number of floors to be served.
- The total elevator travel and each floor-to-floor height.
- Operation system.
- Selected design and size of car.
- Entrance design.
- Signal equipment.
- A sketch of the part of the building where the elevators are to be installed.
- The voltage, number of phases, and frequency of the power source for the motor and lighting.



Mitsubishi Elevator Asia Co., Ltd. has acquired ISO 9001 certification from the International Standards Organization (ISO) based on a review of quality management. The plant has also acquired environmental management system standard ISO 14001 certification.



for a greener tomorrow

Eco Changes is the Mitsubishi Electric Group's environmental statement, and expresses the Group's stance on environmental management. Through a wide range of businesses, we are helping contribute to the realization of a sustainable society.

MITSUBISHI ELECTRIC CORPORATION

HEAD OFFICE : TOKYO BLDG., 2-7-3, MARUNOUCHI, CHIYODA-KU, TOKYO 100-8310, JAPAN

Visit our website at:

<http://www.mitsubishielectric.com/elevator/>

⚠ Safety Tips: Be sure to read the instruction manual fully before using this product.

Revised publication effective Mar. 2015.
Superseding publication of C-CL1-3-C9113-C Nov. 2014.
Specifications are subject to change without notice.

©2015 Mitsubishi Electric Corporation